

## PRODUCT DATA SHEET

---

Part number 210306

---

EAN 4015609011919

Manufacturer WALTHER-WERKE

WEEE-Reg.-Nr: DE 22131895

### Product description

---

Plug 16A 3P 6h with grommet



Product Image

### Detailed product description

---

WALTHER Plug 16A 3P 230V 6h IP44

made from PA6 material

with screw terminal

and grommet

Increased safety due to injected 2K seal and two contact screws.

### Ordering information

---





order unit	Piece
customs number	85366990
net weight	0.1126 kg
packing quantity (VPE)	10
length of the packaging	0.31 m
width of the packaging	0.163 m
depth of the packaging	0.113 m
gross weight(VPE)	1.238 kg

### Conformities

---

CE conformity	v
RoHS directive	2011/65/EU
RoHS directive	2015/863/EU
REACH regulation	1907/2006

## Certification

VDE/ENEC certification	40024787	
UL certification	No. E329476	
UL certification	No. E188992	
CQC certification	2004010203136980	
EAC certification	BY112.02.01.020 06090	

## Classification system

classification system	ETIM_7.0
ETIM Class	EC000140

## Technical product data

IEC-amperage	16 A
Amperage according to UL/CSA (for UL-version)	20 A
Number of poles	3
Voltage according to EN 60309-2	230 V (50+60Hz) blue
Clock hour position	6 h
Identification colour	Blue
Conductor cross-section	1 - 2.5 mm <sup>2</sup>
Cable diameter	7 - 13 mm
Cable strip length	30 mm +/- 2 mm
Cable ferrules length	10 mm +/- 1 mm
Maximum torque terminal screw	0.8 Nm
Maximum torque cable gland	4 Nm
Degree of protection (IP)	IP44
Connection system	Screwed terminal
Contact material	Brass standard
Cable entry	Anti-kink sleeve
Angle of plug	Straight
Material	Plastic
Inflammability class of insulation material according to with UL94	V2

## Dimension sheet

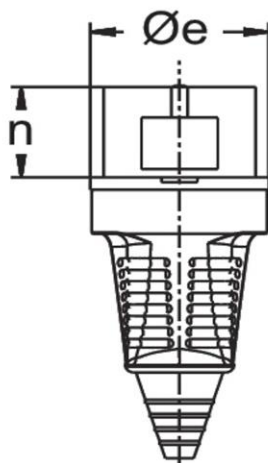
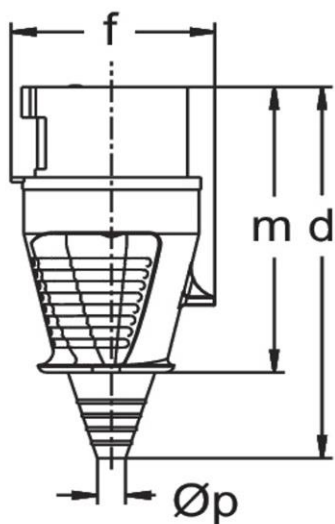

<b>Amp.</b>	<b>16</b>
<b>Pole</b>	<b>3</b>
<b>d</b>	<b>143</b>
<b>Øe</b>	<b>51</b>
<b>f</b>	<b>60</b>
<b>m</b>	<b>108</b>
<b>n</b>	<b>37</b>
<b>Øp</b>	<b>7/13</b>