

PRODUCT DATA SHEET

Part number 319

EAN 4015609000449

Manufacturer WALTHER-WERKE

WEEE-Reg.-Number: DE 22131895

Product description

Waterproof coupler 16A 5P 6h with external cable gland



Similar image

Detailed product description

WALTHER Coupler 16A 5P 400V 6h IP67

made from PA6 material

with screw terminal

and external cable gland







Increased safety due to injected 2K seal

and two contact screws.

Ordering Information

Order unit	Piece
Customs number	85366990
Net weight	0,2982 kg
Packing quantity (VPE)	10
Length of the packaging	0,31 m
Width of the packaging	0,255 m
Depth of the packaging	0,15 m
Gross weight(VPE)	3,178 kg

Certificates

VDE certification	123016	
UL certification	No. E329476	
UL certification	No. E188992	
CQC certification	2004010203136950	
EAC certification	BY112.02.01.020 06101	
CSA certification	70096522	

Classification system

Classification system	ETIM_6.0
ETIM Class	EC001320

Technical product data

IEC-amperage	16 A
Amperage acc. UL/CSA (for UL-version)	20 A
Number of poles	5
Voltage acc. EN 60309-2	400 V (50+60 Hz) red
Clock hour position	6 h
Identification colour	Red
RAL-number	3000
Degree of protection (IP)	IP67
Connection system	Screwed terminal
Angle of plug	Straight
Cable entry	Swivel
Material	Plastic

Dimension sheet

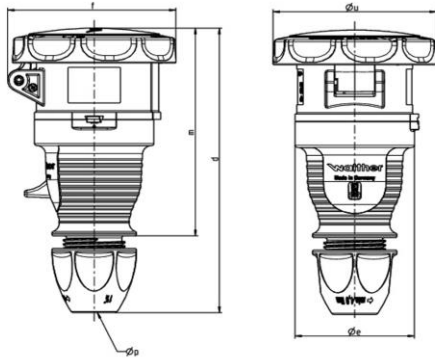

Amp.	16	16	32	32
Pole	4	5	3 / 4	5
d	150-161	150-161	174-183	174-183
Ø e	Ø 65	Ø 65	Ø 72	Ø 72
f	85	92	95	104
m	125	125	142	142
Ø u	Ø 81	Ø 89	Ø 95	Ø 100
Ø p	7,5 - 18,5	7,5 - 18,5	10 - 22,5	10 - 22,5