

ESMKV 50

Cable gland hexagonal, brass nickel-plated, M50, with short thread

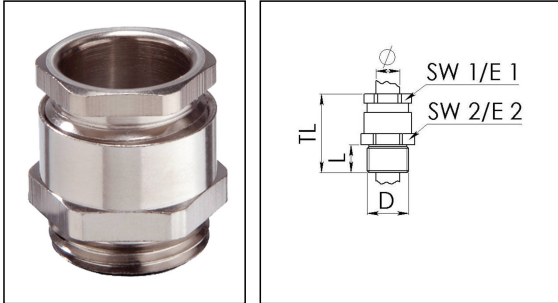

Products may differ in size, colour and appearance to those shown. If you require further information or customisation, please contact us directly.



Material cable gland	Brass nickel-plated
Material sealing gasket	Soft rubber
Temp. range min	-30 °C
Temp. range max	80 °C
Protection class	IP54
Thread type	M
Ø Connection thread D	50
Lead	1,5
Length screw-in thread L	9 mm
Ø cable diameter min	31 mm
Ø cable diameter max	42 mm
Key width SW1	50 mm
Key width SW2	52 mm
Collar diameter E1	54 mm
Collar diameter E2	56 mm
Total length TL	48 mm
Impact category	6
Surface	Nickel-plated
Order no. nickel-plated	10062876
Packing unit	5
Type	ESMKV 50
Tariff number	74198090
EAN number	4007685628761
ETIM-Classification	EC000441

Your Contact:

WISKA Hoppmann GmbH

Kisdorfer Weg 28 · 24568 Kaltenkirchen · Germany

☎ +49-4191-508-0 · 📠 +49-4191-508-209

contact@wiska.de · www.wiska.com

Recommended accessories

EMMU 50	10063147
ORD-E 50	10064703

06.12.2023

Your Contact:

WISKA Hoppmann GmbH

Kisdorfer Weg 28 · 24568 Kaltenkirchen · Germany

 +49-4191-508-0 ·  +49-4191-508-209

contact@wiska.de · www.wiska.com

