

ESVG 25 BK

Pressure compensation cable gland, polyamide, RAL 9005, M25

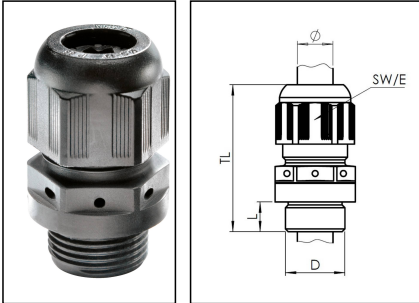

Products may differ in size, colour and appearance to those shown. If you require further information or customisation, please contact us directly.



Material cable gland	Polyamide
Material membrane	ePTFE
Material sealing gasket	EPDM
Airflow at 70mbar	65 l/h
Temp. range min	-40 °C
Temp. range max	100 °C
Glow wire test	750 °C
Protection class	IP68 / IP69
Thread type	M
Ø Connection thread D	25
Lead	1,5
Length screw-in thread L	10 mm
Ø cable diameter min	9 mm
Ø cable diameter max	17 mm
Key width SW	29 mm
Collar diameter (E)	32 mm
Install. torques fitting	4 N m
Install. torques cap nut	4 N m
Total length TL	45 mm - 54 mm
Equipment	Incl. connection thread gasket
Product Color	RAL 9005
Order no. RAL 9005	10100667
Type	ESVG 25 BK
Packing unit	1
EAN number	4007685058117

Your Contact:

WISKA Hoppmann GmbH

Kisdorfer Weg 28 · 24568 Kaltenkirchen · Germany

☎ +49-4191-508-0 · 📠 +49-4191-508-209

contact@wiska.de · www.wiska.com

Tariff number	39269097
ETIM-Classification	EC000441

Recommended accessories

MFD 25/02/060	10060452
RDE 25	10060768
MFD 25/02/080	10060952
EMUG 25 BK	10061783
MFD 25/02/070	10063995
BS 17	10064012
MFD 25/03/070	10064342
MFD 25/04/060	10064343
MFD 25/01/105-01/055	10101255
MFD 25/05/056	10102023

06.12.2023

Your Contact:

WISKA Hoppmann GmbH

Kisdorfer Weg 28 · 24568 Kaltenkirchen · Germany

☎ +49-4191-508-0 · 📠 +49-4191-508-209

contact@wiska.de · www.wiska.com

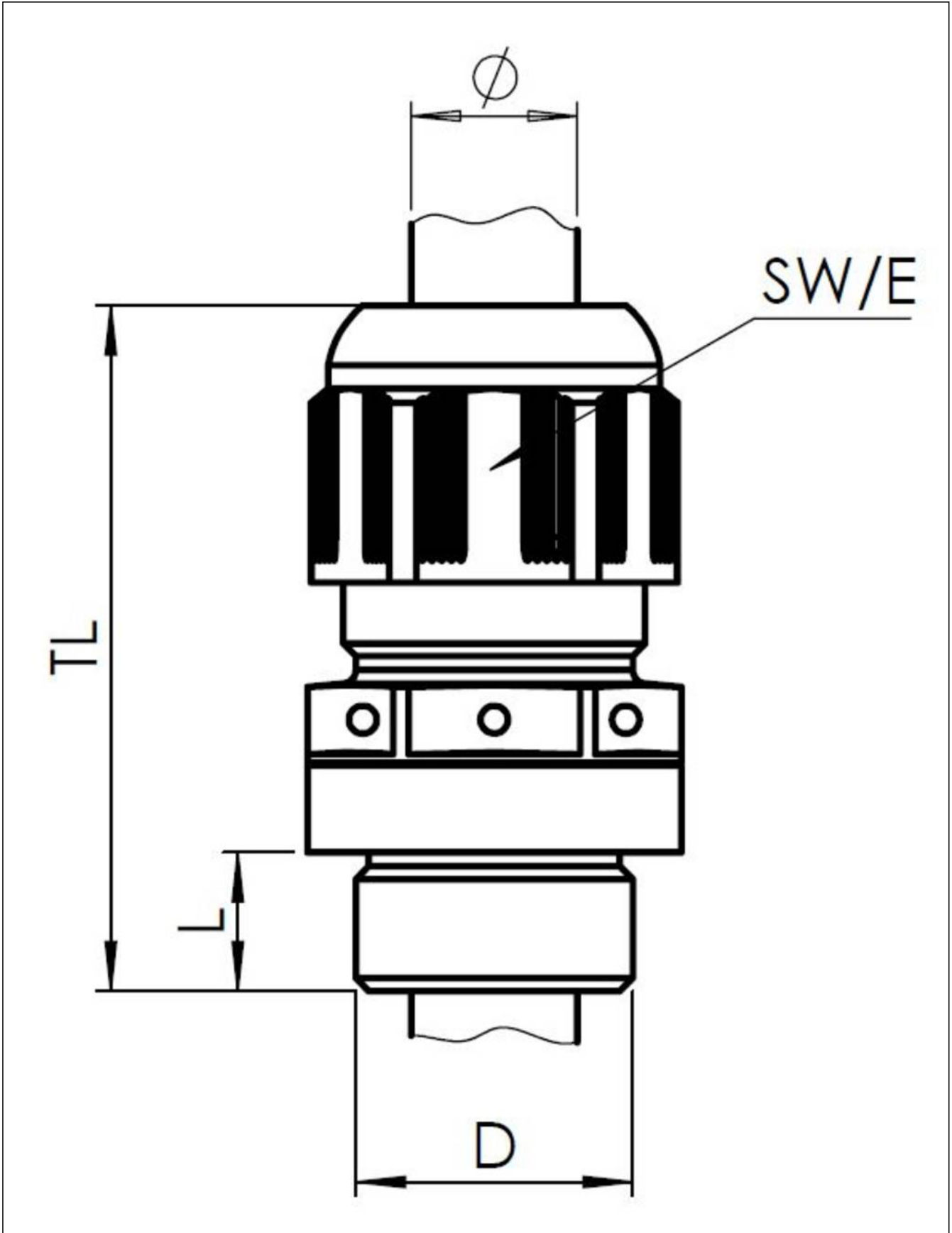

Your Contact:
WISKA Hoppmann GmbH
Kisdorfer Weg 28 · 24568 Kaltenkirchen · Germany
☎ +49-4191-508-0 · 📠 +49-4191-508-209
contact@wiska.de · www.wiska.com