



- Loadmonitors - series GAMMA
- Multifunction
- Fault latch
- Recognition of disconnected consumers
- Suitable for VFI (10 to 100Hz)
- Supply voltage selectable via power modules
- 1 change-over contact
- Width 22.5mm
- Industrial design



Technical data

1. Functions

True power monitoring in 1- or 3-phase mains with adjustable threshold, fixed hysteresis, timing for start-up suppression and tripping delay separately adjustable, fault latch and and the following functions which are selected by means of rotary switch:

OVER	Overload monitoring
OVER+I=0	Overload monitoring with recognition of disconnected consumers
UNDER	Underload monitoring
UNDER+I=0	Underload monitoring with recognition of disconnected consumers

2. Time ranges

	Adjustment range
Start-up suppression time:	1s 100s
Tripping delay:	0.1s 50s

3. Indicators

Green LED U/t ON:	indication of supply voltage
Green LED U/t flashes:	indication of start-up suppression time
Yellow LED R ON/OFF:	indication of relay output
Yellow LED I=0 ON/OFF:	indication of disconnected consumers
Red LED Failure ON/OFF:	indication of failure of the corresponding threshold
Red LED Failure flashes:	indication of tripping delay of the corresponding threshold

4. Mechanical design

Self-extinguishing plastic housing, IP rating IP40
 Mounted on DIN-Rail TS 35 according to EN 60715
 Mounting position: any
 Shockproof terminal connection according to VBG 4 (PZ1 required), IP rating IP20
 Tightening torque: max. 1Nm
 Terminal capacity:
 1 x 0.5 to 2.5mm² with/without multicore cable end
 1 x 4mm² without multicore cable end
 2 x 0.5 to 1.5mm² with/without multicore cable end
 2 x 2.5mm² flexible without multicore cable end

5. Input circuit

Supply voltage:	12 to 400V a.c.	terminals A1-A2 (galvanically separated) selectable via power modules TR2
Tolerance:		according to specification of power module
Rated frequency:	24V d.c.	according to specification of power module terminals A1-A2 (galvanically separated) selectable via switching power supply SNT2
Tolerance:		according to specification of switching power supply
Rated frequency:		according to specification of switching power supply
Rated consumption:		2VA (1.5W)
Duration of operation:		100%
Reset time:		500ms
Residual ripple for d.c.:		-

Drop-out voltage:	>30% of the supply voltage
Overvoltage category:	III (in accordance with IEC 60664-1)
Rated surge voltage:	4kV

6. Output circuit

1 potential free change-over contact	
Rated voltage:	250V a.c.
Switching capacity:	750VA (3A / 250V a.c.)
If the distance between the devices is less than 5mm.	
Switching capacity:	1250VA (5A / 250V a.c.)
If the distance between the devices is greater than 5mm.	
Fusing:	5A fast acting
Mechanical life:	20 x 10 ⁶ operations
Electrical life:	2 x 10 ⁵ operations
	at 1000VA resistive load
Switching frequency:	max. 60/min at 100VA resistive load
	max. 6/min at 1000VA resistive load (in accordance with IEC 60947-5-1)

Overvoltage category:	III (in accordance with IEC 60664-1)
Rated surge voltage:	4kV

7. Measuring circuit

Measuring range P _N :	0.5, 1, 2 and 4kW selectable
Wave form:	
a.c. Sinus:	10 to 400Hz
Sinus-weighted PWM:	10 to 100Hz
Measuring-input voltage:	terminals L1-L2-L3
1-phase mains	0 to 230V a.c.
3-phase mains	3~ 0 to 415/240V
Overload capacity:	
1-phase mains	300V a.c.
3-phase mains	3~ 500/289V
Input resistance:	2MΩ
Measuring-input current:	terminals i-k
Power range 0.5, 1kW:	0 to 6A
Power range 2, 4kW:	0 to 12A (for I>8A distance >5mm)
Overload capacity:	12A permanently
Input resistance:	<10mΩ
Switching threshold:	5% to 120% of P _N
Hysteresis:	fixed, approx. 3% of P _N
Overvoltage category:	III (in accordance with IEC 60664-1)
Rated surge voltage:	4kV

8. Control contact Y (equipotential with measuring circuit)

Function:	fault latch (Y1-Y2 bridged)
Loadable:	No
Line length Y1-Y2:	max. 10m (twisted pair)
Control pulse length:	-
Reset:	normally closed contact in the input circuit

9. Accuracy

Base accuracy:	±2% (of maximum scale value)
Frequency response:	±0.025% / Hz
Adjustment accuracy:	≤5% (of maximum scale value)
Repetition accuracy:	±2%
Voltage influence:	-
Temperature influence:	≤0.2% / °C

Technical data

10. Ambient conditions

- Ambient temperature: -25 to +55°C (in accordance with IEC 60068-1)
- Storage temperature: -25 to +70°C
- Transport temperature: -25 to +70°C
- Relative humidity: 15% to 85%
(in accordance with IEC 60721-3-3 class 3K3)
- Pollution degree: 3 (in accordance with IEC 60664-1)
- Vibration resistance: 10 to 55Hz 0.35mm
(in accordance with IEC 60068-2-6)
- Shock resistance: 15g 11ms
(in accordance with IEC 60068-2-27)

Functions

When the supply voltage U is applied, the output relays switch into on-position (yellow LED R and LED I=0 illuminated) and the set interval of the start-up suppression (START) begins (green LED U/t flashes). Changes of the measured true power during this period do not affect the state of the output relay. After the interval has expired the green LED is illuminated steadily.

Overload monitoring (OVER)

When the measured true power exceeds the value adjusted at the P_N-regulator, the set interval of the tripping delay (DELAY) begins (red LED P Failure flashes). After the interval has expired (red LED P Failure illuminated), the output relay switches into off-position (yellow LED R not illuminated). The output relay switches into on-position again (yellow LED R illuminated), when the measured true power falls below the value adjusted at the P_N-regulator by more than the fixed hysteresis (red LED P Failure not illuminated).

If the fault latch is activated (bridge Y1-Y2) and the measured true power remains above the MAX-value longer than the set interval of the tripping delay, the output relay remains in the off-position even if the measured true power falls below the value adjusted at the P_N-regulator by more than the fixed hysteresis. After resetting the failure (interrupting and re-applying the supply voltage), the output relay switches into on-position and a new measuring cycle begins with the set interval of the start-up suppression (START).

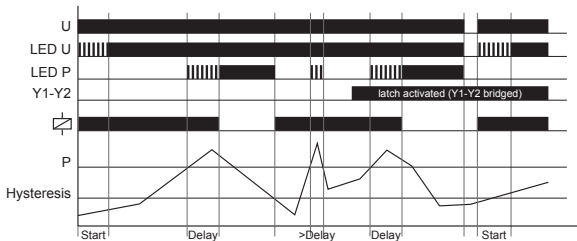

Underload monitoring (UNDER)

When the measured true power falls below the value adjusted at the P_N-regulator, the set interval of the tripping delay (DELAY) begins (red LED P Failure flashes). After the interval has expired (red LED P Failure illuminated), the output relay switches into off-position (yellow LED R not illuminated). The output relay switches into on-position again (yellow LED R illuminated), when the measured true power exceeds the value adjusted at the P_N-regulator by more than the fixed hysteresis. If the fault latch is activated (bridge Y1-Y2) and the measured true power remains below the P_N-value longer than the set interval of the tripping delay, the output relay remains in the off-position even if the measured true power exceeds the value adjusted at the P_N-regulator by more than the fixed hysteresis. After resetting the failure (interrupting and re-applying the supply voltage), the output relay switches into on-position and a new measuring cycle begins with the set interval of the start-up suppression (START).

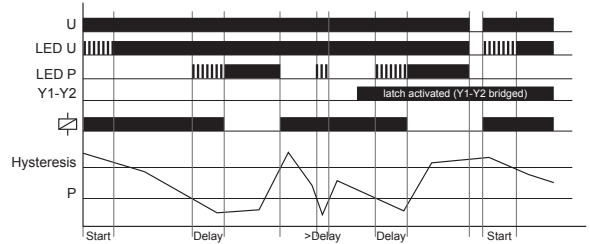

Recognition of disconnected consumers

Recognition of disconnected consumers (I=0) is selectable for all functions. When the current flow between i and k is interrupted (yellow LED I=0 illuminated) and no fault has been stored the operation of the output relay is inverted compared to the standard function. When the current flow is interrupted and the monitoring of overload is activated (OVER+I=0) the relay switches into off-position (yellow LED R not illuminated). If the monitoring of underload is activated (UNDER+I=0) the relay switches into on-position (yellow LED R illuminated). When the current flow is restored, the measuring cycle is restarted with the set interval of the start-up suppression (START).

I=0 with overload monitoring

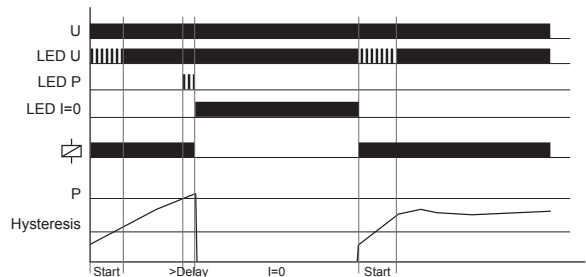

I=0 with underload monitoring

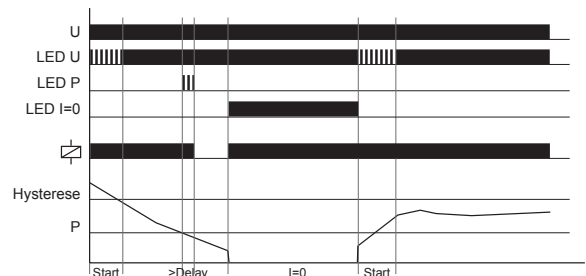

Functions

Connected to 3~ 400V mains with power module 24V a.c. without fault latch
 $I_N < 12A$

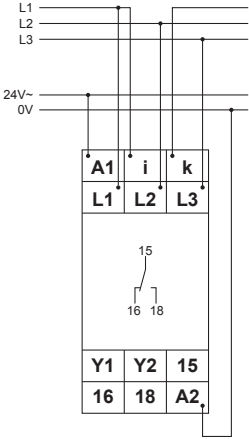

Connections

Connected to 1~ 230V mains with power module 230V a.c. without fault latch
 $I_N > 12A$

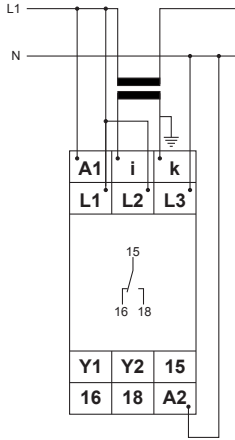

Connected to 1~ 230V mains with power module 230V a.c. without fault latch
 $I_N < 12A$

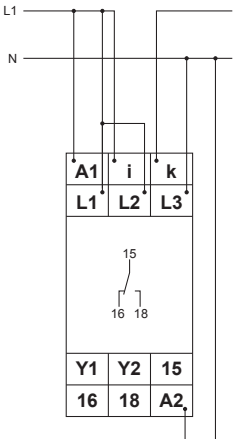

Dimensions

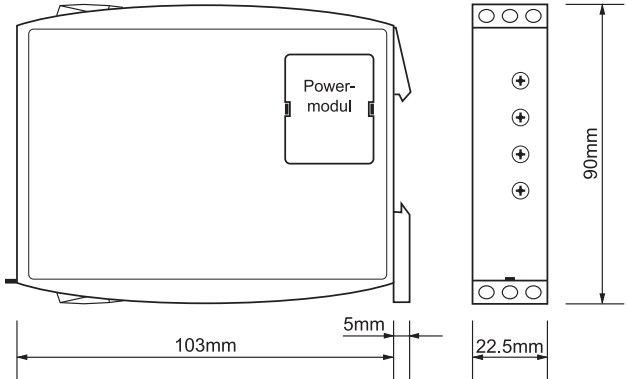

Connected to 3~ 400V mains with power module 400V a.c. and fault latch
 $I_N < 12A$

