

Technical data sheet

Centre suspension mesh cable tray

Item no. 6015239



Two-part centre suspension of mesh cable trays.



St	Steel
FS	Strip galvanised

Additional product text, instruction | When filling with cables, please ensure an even distribution. The maximum recommended mesh cable tray width is 200 mm.

Master data

Item no.	6015239
Type	GMA M8 FS
Description 1	Centre suspension
Description 2	for threaded rod M8
Dimension	60x40
Material	Steel
Material symbol	St
Surface	Strip galvanised
Surface to DIN	DIN EN 10346
Surface symbol	FS
Smallest sales unit (VG)	25,00 Piece
Weight	8,30 kg/100 pc.

Technical data sheet

Centre suspension mesh cable tray



Item no. 6015239

Technical data

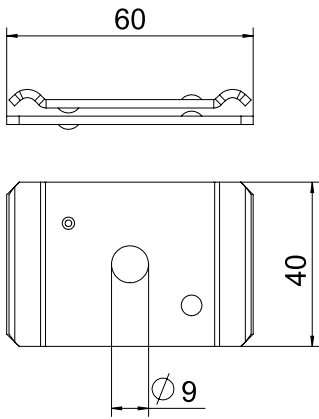

Length	65,00 mm
Width	40,00 mm
Height	10,10 mm
Version	Suspended
Suitable for maintaining electrical function	<input type="checkbox"/>
Hole diameter	9,00 mm
Adjustable	<input type="checkbox"/>

Appr. load:

Technical data sheet

Centre suspension mesh cable tray

Item no. 6015239



Technical data

Appr. load: