

Wire end sleeve insulated 0.5 mm² - 8 mm A00557

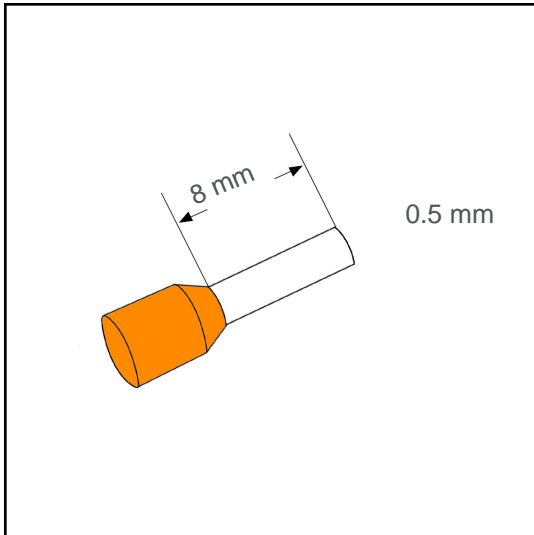

Datasheet:

Cross section (mm ²):	0.5
AWG:	20
Length (mm):	8
Color:	orange
Material:	E-Cu / Polypropylene
Surface:	tin plated
Minimum thickness of tin coating:	3 μm
Max. Temp:	105°C
REACH/RoHS:	confirmed

Packing sizes:

500 pcs.:	Part no.: 005617
10 x 100 pcs.:	Part no.: 005616
50000 pcs.:	Part no.: 005149

Dimensions (mm):

l1	l2	d1	s1	d2	s2
14	8	1.1	0.15	2.4	0.3

