

Wire end sleeve insulated 0.75 mm² - 8 mm A00755

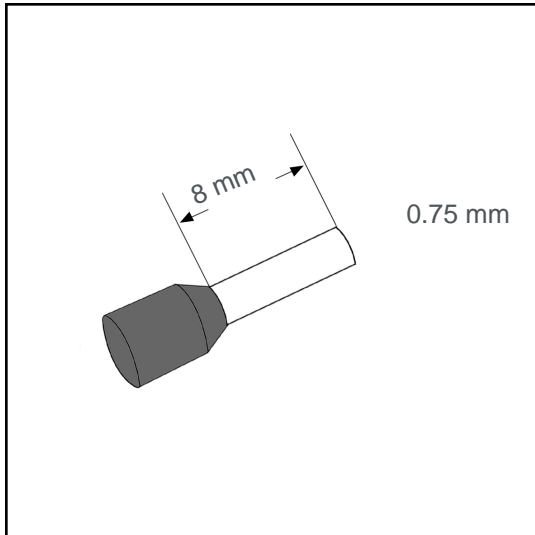

Datasheet:

Cross section (mm ²):	0.75
AWG:	18
Length (mm):	8
Color:	grey
Material:	E-Cu / Polypropylene
Surface:	tin plated
Minimum thickness of tin coating:	3 µm
Max. Temp:	105°C
REACH/RoHS:	confirmed
Certificates:	UL
DIN:	DIN 46228 T4

Packing sizes:

500 pcs.:	Part no.: 005656
10 x 100 pcs.:	Part no.: 005655
50000 pcs.:	Part no.: 005157

Dimensions (mm):

l1	l2	d1	s1	d2	s2
14	8	1.3	0.15	2.7	0.3

