

Wire end sleeve uninsulated 16 mm² - 18 mm B16018

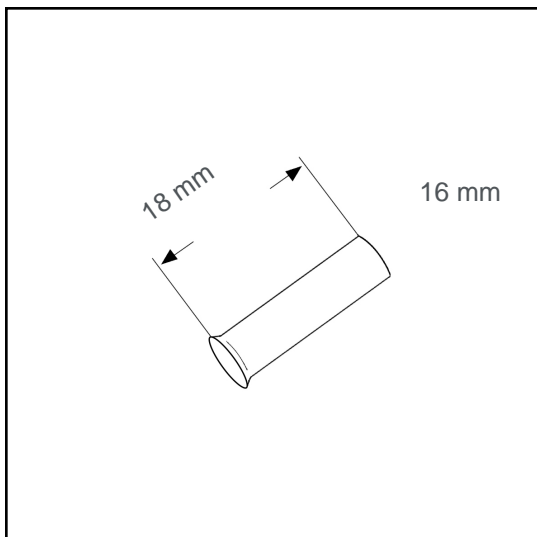

Datasheet:

Cross section (mm ²):	16
AWG:	6
Length (mm):	18
Material:	E-Cu
Surface:	tin plated
Minimum thickness of tin coating:	3 µm
Max. Temp:	105°C
REACH/RoHS:	confirmed
Certificates:	UL
DIN:	DIN 46228 T1

Packing sizes:

250 pcs.:	Part no.: 006081
pcs.:	Part no.: 005440

Dimensions (mm):

l1	d1	s1	d2
18	5.8	0.2	7.5

