

Wire end sleeve insulated 2.5 mm² - 18 mm

A02585

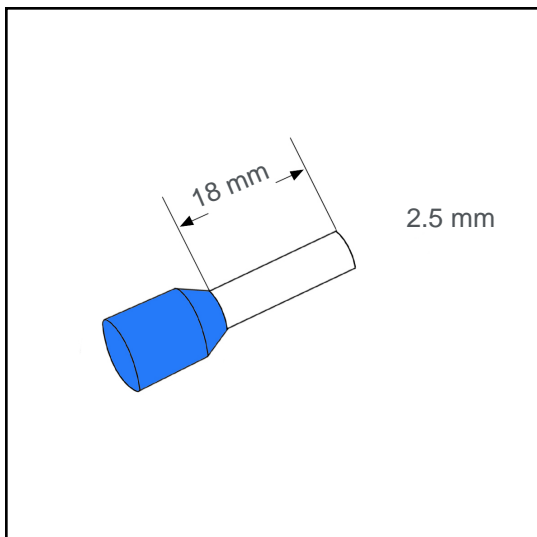

Datasheet:

Cross section (mm ²):	2.5
AWG:	14
Length (mm):	18
Color:	blue
Material:	E-Cu / Polypropylene
Surface:	tin plated
Minimum thickness of tin coating:	3 µm
Max. Temp:	105°C
REACH/RoHS:	confirmed
Certificates:	UL
DIN:	DIN 46228 T4

Packing sizes:

500 pcs.:	Part no.: 005849
10 x 100 pcs.:	Part no.: 005848
50000 pcs.:	Part no.: 005190

Dimensions (mm):

l1	l2	d1	s1	d2	s2
25	18	2.3	0.15	4.1	0.3

