

Wire end sleeve uninsulated 25 mm² - 25 mm B25025

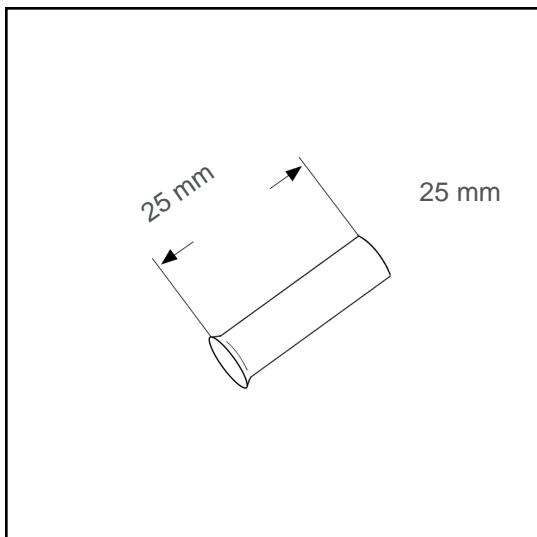

Datasheet:

Cross section (mm ²):	25
AWG:	4
Length (mm):	25
Material:	E-Cu
Surface:	tin plated
Minimum thickness of tin coating:	3 µm
Max. Temp:	105°C
REACH/RoHS:	confirmed
Certificates:	UL
DIN:	DIN 46228 T1

Packing sizes:

100 pcs.:	Part no.: 006094
pcs.:	Part no.: 005451

Dimensions (mm):

l1	d1	s1	d2
25	7.3	0.2	9.5

