

Wire end sleeve uninsulated 4 mm² - 9 mm B04009

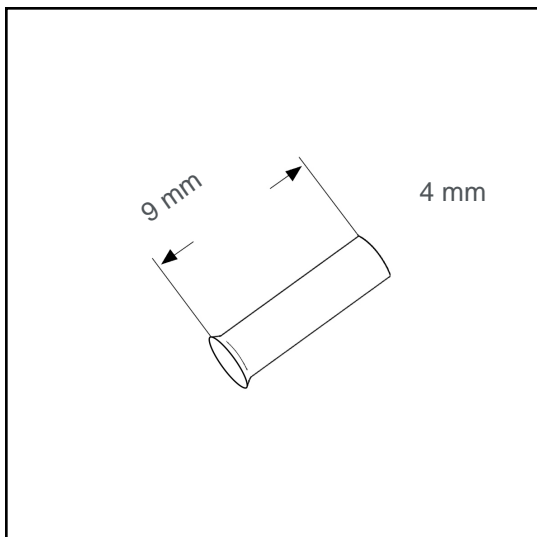

Datasheet:

Cross section (mm ²):	4
AWG:	12
Length (mm):	9
Material:	E-Cu
Surface:	tin plated
Minimum thickness of tin coating:	3 µm
Max. Temp:	105°C
REACH/RoHS:	confirmed
Certificates:	UL
DIN:	DIN 46228 T1

Packing sizes:

1000 pcs.:	Part no.: 006050
pcs.:	Part no.: 005416

Dimensions (mm):

l1	d1	s1	d2
9	2.8	0.2	4

