



KV Circuit breaker boxes 3-54 modules



KV 9104

- 4.5 modules: 1 x 4.5 x 18 mm





- 1-row
- per PE/N number x cross section 2 x 25 mm², 4 x 4 mm² Cu, FIXCONNECT[®] terminal technology, for terminal technology refer to technical data
- for the installation of DIN rail equipment up to 63 A, top hat profile 35 mm
- with transparent lid, sealable
- locking device for hinged lid and sealing facility see accessories
- with cable entry cover
- protective cover can be cut out
- cable entry via integrated elastic membranes
- degree of protection: IP 65
- colour: grey, RAL 7035

rated insulation voltage	U _i = 400 V a.c.
power dissipation capability	P _{de} = 12 watts at 30 K according to EN 60670-24
protection class	II
material	PS (Polystyrene)
width	126 mm
height	228 mm
depth	111 mm
weight	0,646 kg

Drawings

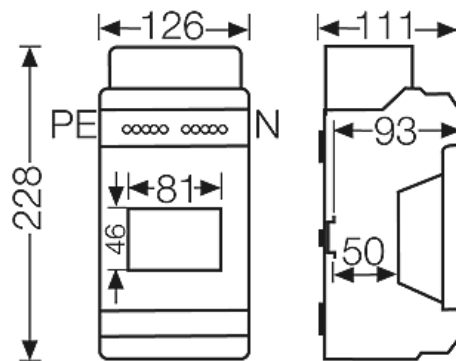
Dimension drawing



KV Circuit breaker boxes 3-54 modules



KV 9104

- 4.5 modules: 1 x 4.5 x 18 mm

IP
65



Detail mass

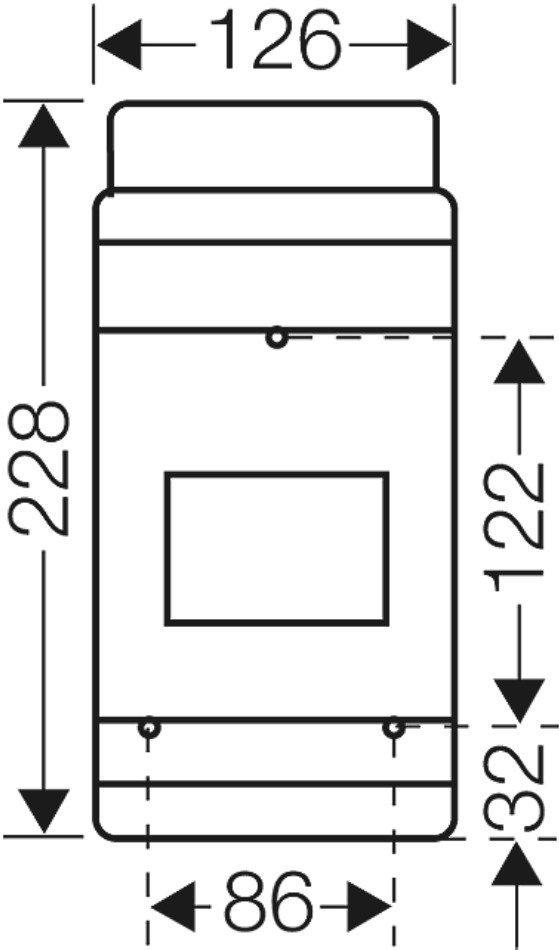

Box walls

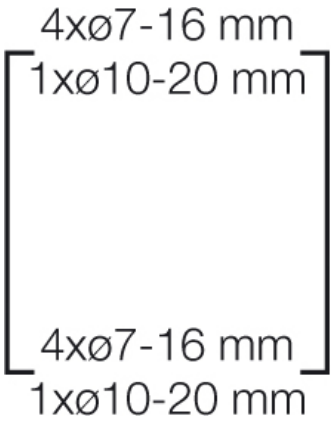

Operating and ambient conditions

Application area	<p>IP 54/65 design: Suitable for indoor installation and outdoor installation, protected against weather influences</p> <p>IP 40/41 design: Suitable for installation in dry indoor areas</p> <p>However, pay attention to the climatic effects on the installed equipment, for example, high or low ambient temperatures or</p>
------------------	--

KV Circuit breaker boxes 3-54 modules



KV 9104

- 4.5 modules: 1 x 4.5 x 18 mm

IP
65



	formation of condensed water see technical information
Ambient temperature	Average value over 24 hours + 35 °C Maximum value + 40 °C Minimum value - 5 °C
Relative humidity	50% at 40° C short-time 100% at 25° C
Fire protection in the event of internal faults	Demands placed on electrical devices from standards and laws Minimum requirements - Glow wire test in accordance with IEC 60695-2-11: - 650°C for boxes and cable glands - 850°C for parts of insulating material necessary to retain current carrying parts in position
Burning behaviour	Glow wire test IEC 60695-2-11: 750 °C UL Subject 94: V-2 flame-retardant self-extinguishing
Degree of protection against mechanical load	IK08 (5 Joule)
Toxic behaviour	halogen-free silicone-free "halogen-free" in accordance with the examination of the cables and insulated wires - corrosiveness of fumes - as per IEC 60754-2
Note:	For material properties see technical data.