



Meter box



Mi 2310

- Max. installation depth: 190 mm
- with meter fixing screws



- use in areas under control or responsibility of local power supply companies
- for meters with three-point fastening
- lid fasteners for tool operation
- can be sealed twice
- material: PC (polycarbonate)
- protection class: II
- colour: grey, RAL 7035

width	300 mm
height	450 mm
depth	214 mm
weight	3,233 kg

Drawings

Dimension drawing

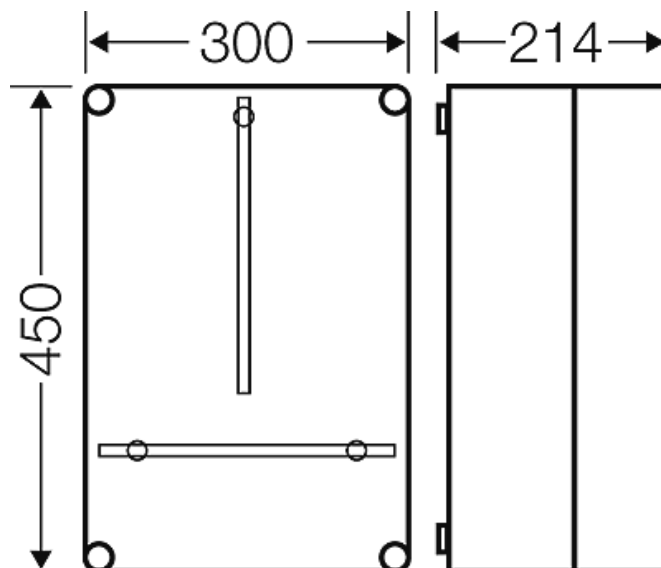

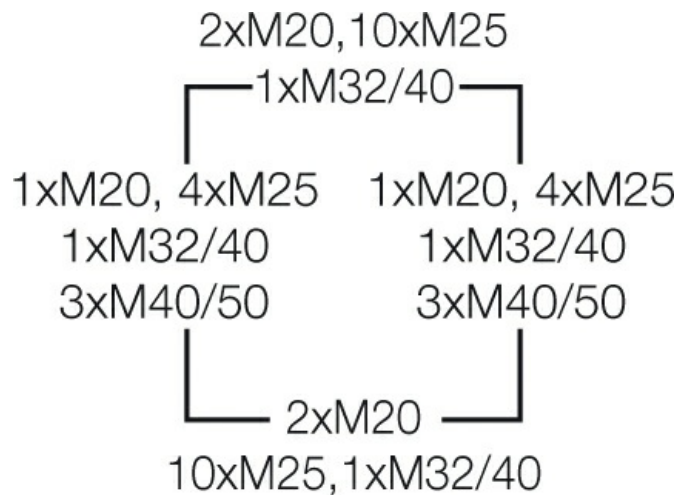

Box walls

Operating and ambient conditions

Application area	Suitable for indoor installation and outdoor installation, protected against weather influences However, pay attention to the climatic effects on the installed equipment, for example, high or low ambient temperatures or formation of condensed water see technical information
Resistant to occasional cleaning procedures (direct jet)	Resistance to occasional cleaning procedures (direct jet) with high-pressure cleaner without cleaning additives, water pressure: max 100 bar, water temperature: Max. 80° C, distance => 0.15 m, in accordance with IP 69 requirements, single enclosure without lid equipment (no enclosure assembly), enclosure and cable glands at least IP 65.
Ambient temperature	Average value over 24 hours + 35 °C Maximum value + 40 °C Minimum value - 5 °C
Relative humidity	50% at 40° C short-time 100% at 25° C
Fire protection in the event of internal faults	Demands placed on electrical devices from standards and laws Minimum requirements - Glow wire test in accordance with IEC 60695-2-11: - 650°C for boxes and cable glands - 850°C for parts of insulating material necessary to retain current carrying parts in position
Burning behaviour	Glow wire test IEC 60695-2-11: 960 °C UL Subject 94: V-2 flame-retardant self-extinguishing
Degree of protection against mechanical load	IK08 (5 Joule)

Toxic behaviour

halogen-free
silicone-free
"halogen-free" in accordance with the examination of the
cables and insulated wires - corrosiveness of fumes - as
per IEC 60754-2

Note:

For material properties see technical data.