

Safety isolating transformer ST 20/23/24



Picture shows ST 160/23-23

Advantages

- Very good switch-on behaviour thanks to reduced starting currents
- High power density due to a compact construction design
- Primary side $\pm 5\%$ tapings for voltage adjustment
- Very good corrosion protection and low noise thanks to BLOCK IMPEX vacuum impregnation
- Contact protected screw connection terminals complying with UVV BGV A3
- Simple mounting thanks to robust metal footplate with oval slots

Applications

As a control transformer for the electrical isolation of the input and output sides. The construction of the transformer is designed to supply control systems according to EN 60204.

As an isolating transformer for the safe electrical isolation of the input and output sides. The transformer may be used to set up protective separation as a protective measure in accordance with VDE 0100.

As a safety isolating transformer for the safe electrical isolation of the input and output sides. The transformer is suitable for creating SELV and PELV circuits because of the limit on the output voltage.

Sample application

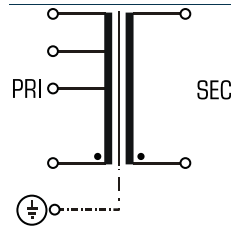

Standards

Safety isolating transformer
to: VDE 0570 Teil 2-6, DIN EN 61558-2-6, EN 61558-2-6, IEC 61558-2-6, UL 5085-1/-2, CSA 22.2 No.66

Approvals



VDE, UL 5085-1/-2, CSA 22.2 No.66



Safety isolating transformer

ST 20/23/24

Type		ST 20/23/24
Electrical data	Input	
	Rated input voltage	230 Vac
	Tappings Input	±5 %
	Rated frequency	50 - 60 Hz
	Output	
	Rated output voltage	24 Vac
	Rated power VDE (DB cos phi=1)	20 VA
	Rated power VDE (KB cos phi=0.5)	42 VA
	No-load voltage (app. x factor)	1.10
	Efficiency	81.0 %
UL Derating	-	
Standards		
Classification	Safety isolating transformer	
Approvals		
Approvals	cURus, VDE	
Environment		
Ambient temperature max.	40 °C	
Type of cooling	self-cooling	
Safety and protection		
Type	Open type	
Insulation class	VDE=B, UL=class 105	
Protection index	IP 00	
Safety class (prepared)	I	
Short circuit strength	non-short-circuit proof	
PRI Fusing recommendation by circuit breaker with tripping characteristic type 20 x Irated related to set)		
Setting range	0.10 - 0.16 A	
Setting value	0.11 A	
Order numbers		
Order Number	ST 20/23/24	

Type		ST 20/23/24
Mechanical data	Terminal and mounting	
	Fixing method	Base plate
	Fixing screws	M4
	Terminals Input	Screw clamp, 4 mm ²
Terminals Output	Screw clamp, 4 mm ²	
Terminals PE	Tab connector, 6.3 x 0.8 mm	
Measures and weights		
Weight	0.70 kg	

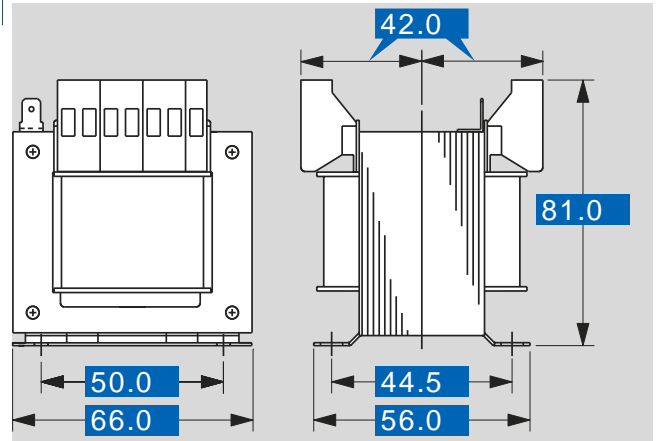

Subject to change.