

Universal control- and safety isolating- resp. isolating transformer **STU 500/2x115**



Picture shows STU 160/24

Advantages

Universal input voltages 210 to 540 Vac
Very good switch-on behaviour thanks to reduced starting currents
High power density due to a compact construction design
Very good corrosion protection and low noise thanks to BLOCK IMPEX vacuum impregnation
Contact protected screw connection terminals complying with UVV BGV A3
Simple mounting thanks to robust metal footplate with oval slots

Applications

As a control transformer for the electrical isolation of the input and output sides. The construction of the transformer is designed to supply control systems according to EN 60204.

As an isolating transformer for the safe electrical isolation of the input and output sides. The transformer may be used to set up protective separation as a protective measure in accordance with VDE 0100.

As a safety isolating transformer for the safe electrical isolation of the input and output sides. The transformer is suitable for creating SELV and PELV circuits because of the limit on the output voltage.

Sample application

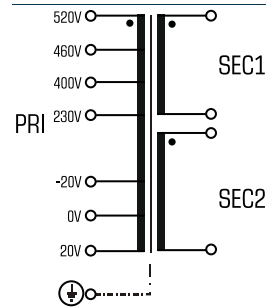

Standards

Isolating transformer
to: VDE 0570 Part 2-4, DIN EN 61558-2-4, EN 61558-2-4, IEC 61558-2-4,
UL 5085-1/-2, CSA 22.2 No.66

Approvals



VDE, UL 5085-1/-2, CSA 22.2 No.66



Universal control- and safety isolating- resp. isolating transformer STU 500/2x115

Type	STU 500/2x115
Electrical data	
Input	
Rated input voltage	210 Vac/230 Vac/250 Vac/ 380 Vac/400 Vac/420 Vac/ 440 Vac/460 Vac/480 Vac/ 500 Vac/520 Vac/540 Vac
Rated frequency	50 - 60 Hz
Output	
Rated output voltage	2 x 115 Vac
Rated power VDE (DB cos phi=1)	500 VA
Rated power VDE (KB cos phi=0.5)	1,370 VA
No-load voltage (app. x factor)	1.05
Efficiency	91.0 %
UL Derating	400 VA
Standards	
Classification	
Approvals	
Approvals	cURus, VDE
Environment	
Ambient temperature max.	40 °C
Type of cooling	self-cooling
Safety and protection	
Type	Open type
Insulation class	VDE=B, UL=class 105
Protection index	IP 00
Safety class (prepared)	I
Short circuit strength	non-short-circuit proof
PRI Fusing recommendation by circuit breaker with tripping characteristic type 20 x Irated related to set)	
Setting range 230 ±20 Vac	1.60 - 2.50 A
Setting value 230 ±20 Vac	2.30 A
Setting range 400 ±20 Vac	1.00 - 1.60 A
Setting value 400 ±20 Vac	1.40 A
Setting range 460 ±20 Vac	1.00 - 1.60 A
Setting value 460 ±20 Vac	1.20 A
Setting range 520 ±20 Vac	1.00 - 1.60 A
Setting value 520 ±20 Vac	1.00 A
Order numbers	
Order Number	STU 500/2x115

Type	STU 500/2x115
Mechanical data	
Terminal and mounting	
Fixing method	Base plate
Fixing screws	M5
Terminals Input	Screw clamp, 4 mm ²
Terminals Output	Screw clamp, 4 mm ²
Terminals PE	Tab connector, 6.3 x 0.8 mm
Measures and weights	
Weight	7.0 kg

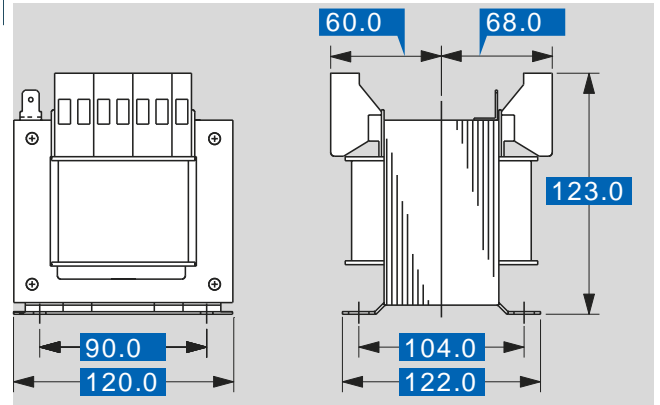

Subject to change.