

# Technical data sheet

## Surge arrester, 3-pole with audible signalling 280 V

Item no. 5096383



Surge arrester, type 2

- Complete unit consisting of upper part and base, pre-mounted and ready for connection
- Suitable for TN network systems
- Plug-in upper part; upper part can be separated from base without tools
- Incl. thermal and dynamic cut-off unit
- With audible signalling for function monitoring, signal tone can be turned off for 24 h
- With visual display of defects
- High current conductivity and long service life
- Labelled connections

Application example: Residential buildings, single-family homes and industrial



Additional product text 1

\* Complete = cover and base

### Dimensions

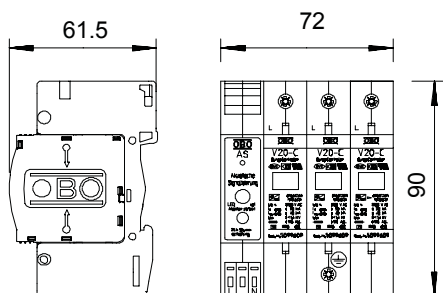

### Master data

Item no.	5096383
Type	V20-C 3+AS-280
Description 1	SurgeController V20
Description 2	with acoustic signalling
Dimension	280V
Smallest sales unit (VG)	1,00 Piece
Weight	44,00 kg/100 pc.

# Technical data sheet

## Surge arrester, 3-pole with audible signalling 280 V

Item no. 5096383



### Technical data

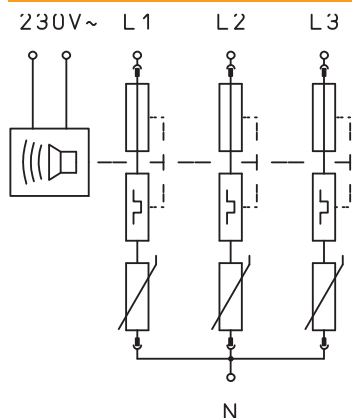

SPD to EN 61643-11	Type 2
SPD to IEC 61643-11	Class II
Test class, type 2	<input checked="" type="checkbox"/>
Nominal voltage	230,00 V
Maximum continuous voltage AC	280,00 V
Max. continuous operating voltage	280,00 V
Nominal discharge current (8/20)	20 kA
Nominal discharge current (8/20 µs) [L-N]	20,00 kA
Maximum discharge current (8/20 µs)	40,00 kA
Arrestor surge current (8/20) [total]	60,00 kA
Protection level	< 1,3 kV
Response time	< 25 ns
Maximum back-up fuse	125,00 A
Temperature range	-40+80 °C
Pole version	3
Version	3-pole with AS; 280 V
Version	3-pole
Mounting type	Hat rail 35 mm
Installation type	DIN rail 35 mm
Protection rating	IP20
Protection rating	IP 20
Blow-out	<input type="checkbox"/>
Division unit TE (17.5 mm)	4
Remote signalling	<input type="checkbox"/>
Telecommunications contact	<input type="checkbox"/>
Integrated back-up fuse	<input type="checkbox"/>
Max. cable cross-section flexible (fine-wire)	25,00 mm <sup>2</sup>
Max. cable cross-section rigid (single wire/multi-wire)	35,00 mm <sup>2</sup>
Connection cross-section, flexible	2,50 - 25,00 mm <sup>2</sup>
Connection cross-section, rigid	2,50 - 35,00 mm <sup>2</sup>
Connection cross-section, multi-wire	2,50 - 35,00 mm <sup>2</sup>
Signalling on device	Optical and acoustic