

Technical data sheet

MCR protection for 2-pole for power supply, 24 V

Item no. 5097607



Surge protection device / fine protection type 3 to EN 61643-11

- Suitable for DC and AC voltage systems
- With visual function display
- With installation-friendly, screwless connection terminals
- In a space-saving 17.5 mm grid
- Y circuit

Application: Universal use on 35 mm DIN profile rail in every normal commercially available distributor housing.



Dimensions

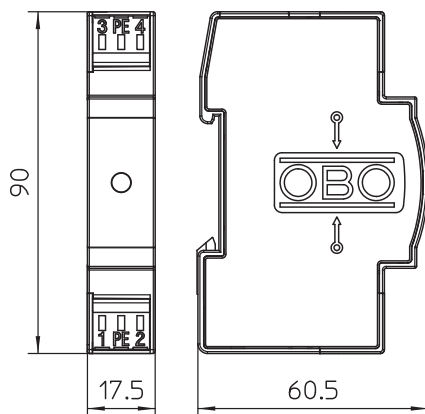

Master data

Item no.	5097607
Type	VF24-AC/DC
Description 1	Lightning barrier
Description 2	for AC and DC
Dimension	24V AC
Smallest sales unit (VG)	1,00 Piece
Weight	8,00 kg/100 pc.

Technical data sheet

MCR protection for 2-pole for power supply, 24 V

Item no. 5097607



Technical data

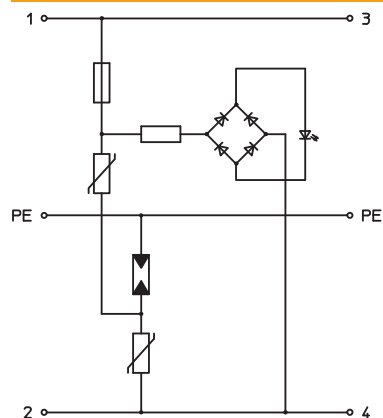

SPD to EN 61643-11	Type 3
SPD to IEC 61643-11	Class III
Test class, type 3	<input checked="" type="checkbox"/>
Nominal voltage	24,00 V
Maximum continuous voltage AC	34,00 V
Max. continuous operating voltage	34,00 V
U max AC	34,00 V
Maximum continuous voltage DC	46,00 V
U max DC	46,00 V
Nominal discharge current (8/20)	0,7 kA
Rated current	20,00 A
Maximum discharge current (8/20 µs)	2,00 kA
Protection level	< 0,13 kV
Response time	<25 ns
Maximum back-up fuse	20,00 A
Temperature range	-40-+80 °C
Pole version	2
Pole number	3,00
Version	24 V version
Version	2-pole
Mounting type	Hat rail 35 mm
Installation type	DIN rail 35 mm
Protection rating	IP20
Protection rating	IP 20
Blow-out	<input type="checkbox"/>
Division unit TE (17.5 mm)	1
Remote signalling	<input type="checkbox"/>
Telecommunications contact	<input type="checkbox"/>
Max. cable cross-section flexible (fine-wire)	2,50 mm ²
Max. cable cross-section rigid (single wire/multi-wire)	2,50 mm ²
Connection cross-section, flexible	0,14 - 2,50 mm ²
Connection cross-section, rigid	0,14 - 2,50 mm ²
Connection cross-section, multi-wire	0,14 - 2,50 mm ²
Signalling on device	Visual